

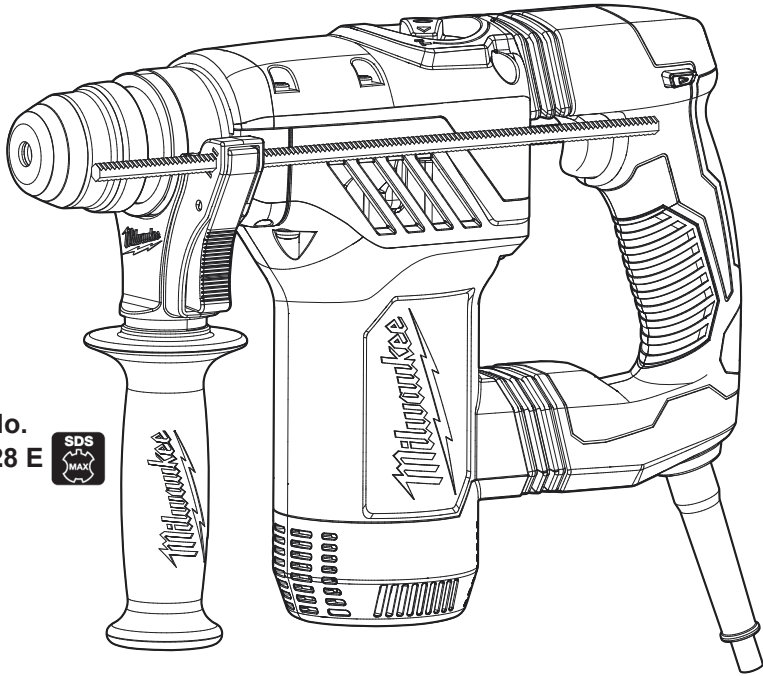

OPERATOR'S MANUAL



Cat. No.
PLH 28 E



28mm (1-1/8") SDS PLUS ROTARY HAMMER

TO REDUCE THE RISK OF INJURY, USER MUST READ AND UNDERSTAND OPERATOR'S MANUAL.

GENERAL POWER TOOL SAFETY WARNINGS

 **WARNING READ ALL SAFETY WARNINGS AND ALL INSTRUCTIONS.** Failure to follow the warnings and instructions may result in electric shock, fire and/or serious injury. **Save all warnings and instructions for future reference.** The term “power tool” in the warnings refers to your mains-operated (corded) power tool or battery-operated (cordless) power tool.

WORK AREA SAFETY

- **Keep work area clean and well lit.** Cluttered or dark areas invite accidents.
- **Do not operate power tools in explosive atmospheres, such as in the presence of flammable liquids, gases or dust.** Power tools create sparks which may ignite the dust or fumes.
- **Keep children and bystanders away while operating a power tool.** Distractions can cause you to lose control.

ELECTRICAL SAFETY

- **Power tool plugs must match the outlet. Never modify the plug in any way. Do not use any adapter plugs with earthed (grounded) power tools.** Unmodified plugs and matching outlets will reduce risk of electric shock.
- **Avoid body contact with earthed or grounded surfaces such as pipes, radiators, ranges and refrigerators.** There is an increased risk of electric shock if your body is earthed or grounded.
- **Do not expose power tools to rain or wet conditions.** Water entering a power tool will increase the risk of electric shock.
- **Do not abuse the cord. Never use the cord for carrying, pulling or unplugging the power tool. Keep cord away from heat, oil, sharp edges or moving parts.** Damaged or entangled cords increase the risk of electric shock.
- **When operating a power tool outdoors, use an extension cord suitable for outdoor use.** Use of a cord suitable for outdoor use reduces the risk of electric shock.
- **If operating a power tool in a damp location is unavoidable, use a residual current device (RCD) protected supply.** Use of an RCD reduces the risk of electric shock.

PERSONAL SAFETY

- **Stay alert, watch what you are doing and use common sense when operating a power tool. Do not use a power tool while you are tired or under the influence of drugs, alcohol or medication.** A moment of inattention while operating power tools may result in serious personal injury.
- **Use personal protective equipment. Always wear eye protection.** Protective equipment such as dust mask, non-skid safety shoes, hard hat, or hearing protection used for appropriate conditions will reduce personal injuries.
- **Prevent unintentional starting. Ensure the switch is in the off-position before connecting to power source and/or battery pack, picking up or carrying the tool.** Carrying power tools with your finger on the switch or energising power tools that have the switch on invites accidents.
- **Remove any adjusting key or wrench before turning the power tool on.** A wrench or a key left

attached to a rotating part of the power tool may result in personal injury.

- **Do not overreach. Keep proper footing and balance at all times.** This enables better control of the power tool in unexpected situations.
- **Dress properly. Do not wear loose clothing or jewellery. Keep your hair, clothing and gloves away from moving parts.** Loose clothes, jewellery or long hair can be caught in moving parts.
- **If devices are provided for the connection of dust extraction and collection facilities, ensure these are connected and properly used.** Use of dust collection can reduce dust-related hazards.

POWER TOOL USE AND CARE

- **Do not force the power tool. Use the correct power tool for your application.** The correct power tool will do the job better and safer at the rate for which it was designed.
- **Do not use the power tool if the switch does not turn it on and off.** Any power tool that cannot be controlled with the switch is dangerous and must be repaired.
- **Disconnect the plug from the power source and/or the battery pack from the power tool before making any adjustments, changing accessories, or storing power tools.** Such preventive safety measures reduce the risk of starting the power tool accidentally.
- **Store idle power tools out of the reach of children and do not allow persons unfamiliar with the power tool or these instructions to operate the power tool.** Power tools are dangerous in the hands of untrained users.
- **Maintain power tools. Check for misalignment or binding of moving parts, breakage of parts and any other condition that may affect the power tool's operation. If damaged, have the power tool repaired before use.** Many accidents are caused by poorly maintained power tools.
- **Keep cutting tools sharp and clean.** Properly maintained cutting tools with sharp cutting edges are less likely to bind and are easier to control.
- **Use the power tool, accessories and tool bits etc. in accordance with these instructions, taking into account the working conditions and the work to be performed.** Use of the power tool for operations different from those intended could result in a hazardous situation.

SERVICE

- **Have your power tool serviced by a qualified repair person using only identical replacement parts.** This will ensure that the safety of the power tool is maintained.

SPECIFIC SAFETY RULES

- **Wear ear protection.** Exposure to noise can cause hearing loss.

• It is recommended that this tool is always supplied with power via a residual current device with a rated residual current of 30mA or less.

• **Use auxiliary handle(s), if supplied with the tool.** Loss of control can cause personal injury.

• **Hold power tools by insulated gripping surfaces, when performing an operation where the cutting tool may contact hidden wiring or its own cord.** Cutting accessory contacting a "live" wire may make exposed metal parts of the power tool "live" and could give the operator an electric shock.

• **Keep hands away from all cutting edges and moving parts.**

• **Maintain labels and nameplates.** These carry important information. If unreadable or missing, contact a MILWAUKEE® service facility for a replacement.

• **WARNING:** Some dust created by power sanding, sawing, grinding, drilling, and other construction activities contains chemicals known to cause cancer, birth defects or other reproductive harm. Some examples of these chemicals are:

• lead from lead-based paint

• crystalline silica from bricks and cement and other masonry products, and

• arsenic and chromium from chemically-treated lumber.

Your risk from these exposures varies, depending on how often you do this type of work. To reduce your exposure to these chemicals: work in a well ventilated area, and work with approved safety equipment, such as those dust masks that are specially designed to filter out microscopic particles.

GROUNDING

 **WARNING** Improperly connecting the grounding wire can result in the risk of electric shock. Check with a qualified electrician if you are in doubt as to whether the outlet is properly grounded. Do not modify the plug provided with the tool. Never remove the grounding prong from the plug. Do not use the tool if the cord or plug is damaged. If damaged, have it repaired by a MILWAUKEE® service facility before use. If the plug will not fit the outlet, have a proper outlet installed by a qualified electrician.

EXTENSION CORDS

Grounded tools require a three wire extension cord. As the distance from the supply outlet increases, you must use a heavier gauge extension cord. Using extension cords with inadequately sized wire causes a serious drop in voltage, resulting in loss of power and possible tool damage. Refer to the table shown to determine the required minimum wire size.

The smaller the area of the wire, the less the capacity of the cord. When using more than one extension cord to make up the total length, be sure each cord contains at least the minimum wire size required. If you are using one extension cord for more than one tool, add the nameplate amperes and use the sum to determine the required minimum wire size.

Guidelines for Using Extension Cords









- If you are using an extension cord outdoors, be sure it is acceptable for outdoor use.
- Be sure your extension cord is properly wired and in good electrical condition. Always replace a damaged extension cord or have it repaired by a qualified person before using it.
- Protect your extension cords from sharp objects, excessive heat and damp or wet areas.

READ AND SAVE ALL INSTRUCTIONS FOR FUTURE USE.

SPECIFICATIONS

Cat. No.	Volts AC	Power input	Tool				Capacities	
			No Load RPM	BPM	Blow Energy	Type	Twist bit	Core bit
PLH 28 E	220 - 230 V	800 W	0 - 1500	0 - 5500	4.8 J	SDS Plus	28mm (1-1/8")	76mm (3")

SYMBOLOLOGY

	Please read the instructions carefully before starting the machine.
	Double Insulated
	Volts
	Alternating Current
	Amps
$n_0 \times \times \times \times \text{min.}^{-1}$	No Load Revolutions per Minute (RPM)
BPM	Blows per Minute (BPM)
	Anti-Vibration System
	Regulatory Compliance Mark (RCM). Product meets applicable regulatory requirements
	Wear Eye Protection
	Do not dispose of electric tools together with household waste material. Electric tools and electronic equipment that have reached the end of their life must be collected separately and returned to an environmentally compatible recycling facility. Check with your local authority or retailer for recycling advice and collection point.

FUNCTIONAL DESCRIPTION

1. Side handle
2. Depth gauge rod
3. Bit holder
4. Bit release collar
5. Mode selector knob
6. Trigger

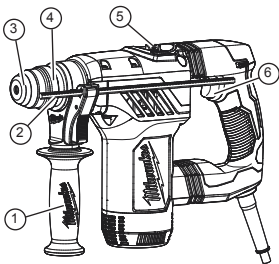

ASSEMBLY

 **WARNING** To reduce the risk of injury, always unplug tool before changing or removing accessories. Only use accessories specifically recommended for this tool. Others may be hazardous.

 **WARNING** To reduce the risk of injury, always use a side handle when using this tool. Always brace or hold securely.

Adjusting the Side Handle Position

1. Loosen the side handle by unscrewing the side handle grip until the side handle rotates freely.
2. Rotate the side handle to the desired position.
3. Tighten the side handle grip securely.

Setting the Depth Gauge

1. Press in the clamping lever.
2. Slide the depth gauge rod backward or forward until it is set for the desired depth.

- NOTE:** The drilling depth is the distance between the tip of the bit and the tip of the depth gauge rod.
3. Release the clamping lever.

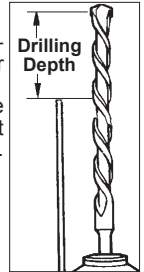

 **WARNING** To reduce the risk of injury, do not grasp the bit while the chuck is rotating or while the bit is falling from the chuck.

Installing Bits and Chisels

NOTE: Only use accessories with SDS or SDS Plus shanks.

Be sure that the shank of the bit is clean. Dirt particles may cause the bit to line up improperly. Do not use bits larger than the maximum recommended capacity of the drill because gear damage or motor overloading may result. For best performance, be sure that the bit is properly sharpened and the shank is lightly greased before use. Use caution when handling hot bits and chisels.

1. Unplug tool.
2. Insert the bit or chisel into the nose of the tool.
3. Push bit into tool until it locks.
5. Check to see that the bit is locked by tugging on it.
6. To remove bits and chisels, pull back on the bit release collar and remove bit.

OPERATION





⚠ WARNING To reduce the risk of injury, always unplug tool before attaching or removing accessories or making adjustments. Use only specifically recommended accessories. Others may be hazardous.

⚠ WARNING To reduce the risk of injury, wear safety goggles or glasses with side shields.

⚠ WARNING To reduce the risk of injury, keep hands and cord away from the bit and all moving parts.

Selecting Action

MILWAUKEE® Rotary Hammers have three settings: rotation only, rotary hammer, and hammer only. Always allow the motor to come to a complete stop before changing the mode selection to avoid damage to the tool.

1. For rotation only, turn the selector lever so the arrow on the lever points to the twist drill  symbol.
2. For rotary hammering, turn the selector lever so the arrow points to the hammer and twist drill  symbol.
3. For hammering only, turn the selector lever so the arrow points to the hammer  symbol.
4. To freely rotate the bit to the desired angle for hammering only, turn the selector lever to the  symbol. Then, follow step 3.

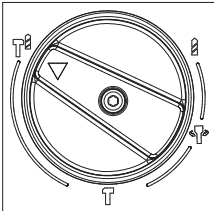

NOTE: To engage the hammering mechanism, maintain pressure on the bit. When pressure on the bit is released, the hammering action will stop.

Starting and Stopping

1. To **start** the tool, grasp the handle firmly and pull the trigger.
2. To **stop** the tool, release the trigger. Make sure the tool comes to a complete stop before laying the tool down.

Using the Control Switch

Always allow the motor to come to a complete stop before using the control switch to avoid damage to the tool.

For **forward** (clockwise) rotation, push in the control switch from the right side of the tool. Check the direction of rotation before use.

For **reverse** (counterclockwise) rotation, push in the control switch from the left side of the tool. Check direction of rotation before use.

Operating

Position the tool, grasp the handles firmly and pull the trigger. Always hold the tool securely using both handles to maintain control. This tool has been designed to achieve top performance with

only moderate pressure. Let the tool do the work. If the speed begins to drop off when drilling large or deep holes, pull the bit partially out of the hole while the tool is running to help clear dust. Do not use water to settle the dust since it will clog the bit flutes and tend to make the bit bind in the hole. If the bit should bind, a built-in, non-adjustable slip clutch prevents the bit from turning. If this occurs, stop the tool, free the bit and begin again.

Cold Starting

If this tool is stored for a long period of time or at cold temperatures, it may not hammer initially because the lubrication has become stiff. To warm up the tool:



1. Insert and lock a bit or chisel into the tool.
2. Pull the trigger and apply force to the bit or chisel against a concrete or wood surface for a few seconds. Release the trigger.
3. Repeat until the tool starts hammering. The colder the tool is, the longer it will take to warm up.

Chiseling and Chipping

MILWAUKEE® Rotary Hammers may be used for chipping and chiseling.

When chiseling, hold the tool at an angle to the workpiece. Work from a corner or close to the edge of the workpiece, breaking off one small area at a time rather than attempting too large an area.

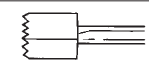
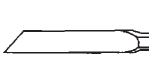
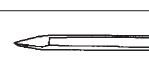
A variety of accessories are available.

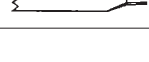
	Bushing Tools Used to surface concrete.
	Mortar Cutting Chisels (Seam Tools) For removing old mortar for tuck pointing or caulking.
	Bull Points For demolition work and starting holes in concrete slabs.
	Flat Chisels For edging, chipping or channeling.
	Scaling Chisels For removing weld spatter or scale and cutting straight lines.
	Slotting Chisel For slotting and cutting between drilled holes in concrete and masonry.

MAINTENANCE

 **WARNING** To reduce the risk of injury, always unplug your tool before performing any maintenance. Never disassemble the tool or try to do any rewiring on the tool's electrical system. Contact a **MILWAUKEE®** service facility for ALL repairs.

 **WARNING** To reduce the risk of injury, electric shock and damage to the tool, never immerse your tool in liquid or allow a liquid to flow inside the tool.

Maintaining Tools

Keep your tool in good repair by adopting a regular maintenance program. Before use, examine the general condition of your tool. Inspect guards, switches, tool cord set and extension cord for damage. Check for loose screws, misalignment, binding of moving parts, improper mounting, broken parts and any other condition that may affect its safe operation. If abnormal noise or vibration occurs, turn the tool off immediately and have the problem corrected before further use. Do not use a damaged tool. Tag damaged tools "DO NOT USE" until repaired (see "Repairs").

Under normal conditions, relubrication is not necessary until the motor brushes need to be replaced. After six months to one year, depending on use, return your tool to the nearest **MILWAUKEE®** service facility for the following:

- Lubrication
- Brush inspection and replacement
- Mechanical inspection and cleaning (gears, spindles, bearings, housing, etc.)
- Electrical inspection (switch, cord, armature, etc.)
- Testing to assure proper mechanical and electrical operation

Cleaning

Clean dust and debris from vents. Keep the tool handles clean, dry and free of oil or grease. Use only mild soap and a damp cloth to clean your tool since certain cleaning agents and solvents are harmful to plastics and other insulated parts. Some of these include: petrol, turpentine, lacquer thinner, paint thinner, chlorinated cleaning solvents, ammonia and household detergents containing ammonia. Never use flammable or combustible solvents around tools.

Repairs

If your tool is damaged, return the entire tool to the nearest service center.

Contact Customer Service or visit our website for a list of guarantee/service addresses.

If needed, an exploded view of the tool can also be ordered. Please state the Article No. as well as the machine type printed on the label and order the drawing at your local service agents or directly from:

customer service centre
(Australia Toll Free Telephone Number 1300 645 928)
(New Zealand Toll Free Telephone Number 0800 279 624)

or visit

www.milwaukeetools.com.au
www.milwaukeetools.co.nz

ACCESSORIES

 **WARNING** To reduce the risk of injury, always unplug the tool before attaching or removing accessories. Use only specifically recommended accessories. Others may be hazardous.

For a complete listing of accessories refer to your **MILWAUKEE®** Electric Tool catalog or go on-line to

www.milwaukeetools.com.au
www.milwaukeetools.co.nz

WARRANTY - AUSTRALIA and NEW ZEALAND

Please refer to the Techtronic Industries Pty. Ltd. Warranty Terms and Conditions for **MILWAUKEE®** products and accessories which is supplied with the tool or kit. This warranty applies only to product purchased from an authorised **MILWAUKEE®** dealer in Australia or New Zealand.

**AUSTRALIA AND NEW ZEALAND
MILWAUKEE® Service**

MILWAUKEE® prides itself in producing a premium quality product that is Nothing But Heavy Duty®. Your satisfaction with our products is very important to us! If you encounter any problems with the operation of this tool, please contact your authorised **MILWAUKEE®** dealer or service centre.

For a list of **MILWAUKEE®** dealers, guarantee or service agents please contact **MILWAUKEE®** Customer Service or visit our website.

(Australia Toll Free Telephone Number 1300 361 505)

(New Zealand Toll Free Telephone Number 0800 279 624) or visit www.milwaukeetools.com.au / www.milwaukeetools.co.nz.

Milwaukee Electric Tool Corporation

13135 West Lisbon Road, Brookfield, Wisconsin U.S.A. 53005

Milwaukee Electric Tool Corporation (Australia)

Techtronic Industries (Australia) Pty. Ltd.
Doncaster, Victoria, Australia, 3108

Milwaukee Electric Tool Corporation (New Zealand)

Techtronic Industries (New Zealand) Pty. Ltd.
Mangere, Auckland, New Zealand, 2022

Professionally made in China for Milwaukee Electric Tool Corporation